

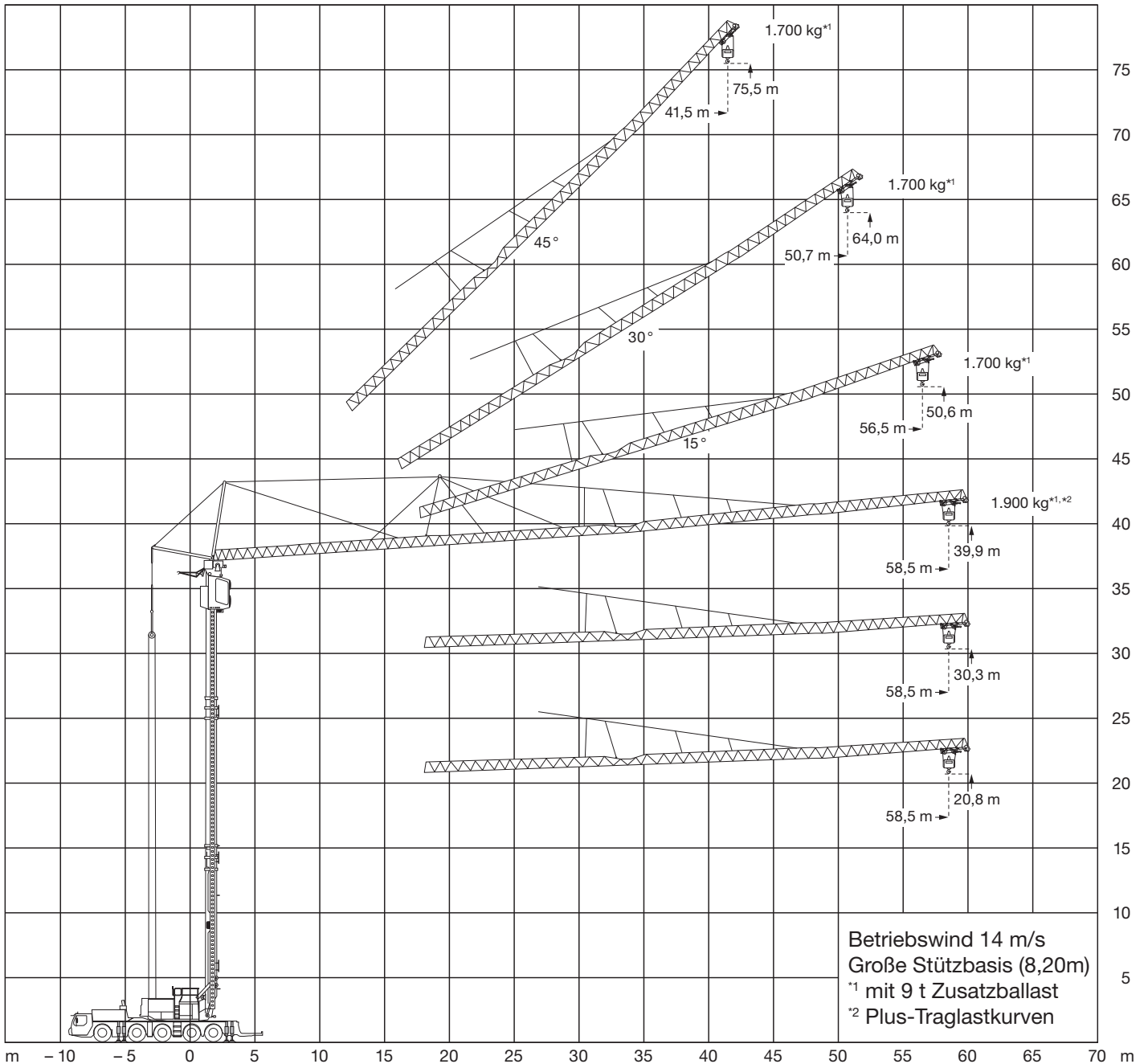

Alle Angaben ohne Gewähr und vorbehaltlich technischer Änderungen und Satzfehler.  
All information given are for reference only

ZERTIFIZIERT  
EN ISO 9001 - SCC<sup>®</sup>



Katzfahrbetrieb







	0°	0° PLUS	15°	30°	45°	
3	8	8	1,8	6	1,8	3
6	8	8	1,8	6	1,8	6
9	8	8	1,8	6	1,8	9
12	8	8	1,8	6	1,8	12
15	7,29	7,71	1,8	6	1,8	15
18	6,22	6,5	1,8	5,32	1,8	18
21	5,4	5,61	1,8	4,54	1,8	21
24	4,75	4,93	1,8	3,94	1,8	24
27	4,23	4,38	1,8	3,48	1,8	27
30	3,79	3,93	1,8	3,1	1,8	30
33	3,42	3,57	1,8	2,79	1,8	33
36	3,11	3,25	1,8	2,53	1,8	36
39	2,83	2,99	1,8	2,31	1,8	39
42	2,6	2,76	1,8	2,12	1,7	42
45	2,39	2,56	1,8	1,96		45
48	2,2	2,38	1,8	1,81		48
51	2,04	2,22	1,8	1,7		51
54	1,89	2,08	1,8			54
57	1,76	1,96	1,7			57
58,5	1,7	1,9				58,5





	0°	0° PLUS	15°	30°	45°	
3	8	8	1,8	6	1,8	3
6	8	8	1,8	6	1,8	6
9	8	8	1,8	6	1,8	9
12	8	8	1,8	6	1,8	12
15	7,11	7,67	1,8	6	1,8	15
18	5,88	6,34	1,8	5,28	1,8	18
21	4,99	5,39	1,8	4,46	1,8	21
24	4,32	4,68	1,8	3,84	1,8	24
27	3,8	4,12	1,8	3,37	1,8	27
30	3,38	3,67	1,8	2,99	1,8	30
33	3,04	3,3	1,8	2,68	1,8	33
36	2,76	3	1,8	2,42	1,8	36
39	2,52	2,74	1,8	2,2	1,8	39
42	2,31	2,51	1,8	2,01	1,7	42
45	2,13	2,32	1,8	1,85		45
48	1,97	2,15	1,8	1,71		48
51	1,83	2	1,75	1,6		51
54	1,71	1,87	1,63			54
57	1,6	1,75	1,55			57
58,5	1,55	1,7				58,5



	0°	0° PLUS	15°	30°	45°	
3	8	8	1,8	6	1,8	3
6	8	8	1,8	6	1,8	6
9	8	8	1,8	6	1,8	9
12	8	8	1,8	6	1,8	12
15	6,24	7,05	1,8	5,55	1,8	15
18	5,09	5,69	1,8	4,51	1,8	18
21	4,28	4,75	1,8	3,79	1,8	21
24	3,68	4,06	1,8	3,25	1,8	24
27	3,22	3,54	1,8	2,83	1,8	27
30	2,85	3,13	1,8	2,5	1,8	30
33	2,55	2,8	1,8	2,23	1,8	33
36	2,3	2,53	1,8	2	1,8	36
39	2,08	2,3	1,8	1,82	1,7	39
42	1,9	2,1	1,74	1,65	1,55	42
45	1,75	1,93	1,6	1,51		45
48	1,61	1,79	1,48	1,39		48
51	1,49	1,66	1,37	1,3		51
54	1,38	1,54	1,27			54
57	1,29	1,44	1,2			57
58,5	1,25	1,4				58,5



	0°	0° PLUS	15°	30°	45°	
3	8	8	1,8	6	1,8	3
6	8	8	1,8	6	1,8	6
9	8	8	1,8	6	1,8	9
12	6,78	8	1,8	6	1,8	12
15	5,25	6,08	1,8	4,61	1,8	15
18	4,26	4,87	1,8	3,72	1,8	18
21	3,56	4,04	1,8	3,09	1,8	21
24	3,05	3,44	1,8	2,63	1,8	24
27	2,66	2,98	1,8	2,28	1,8	27
30	2,34	2,62	1,8	2	1,8	30
33	2,09	2,33	1,8	1,77	1,65	33
36	1,88	2,09	1,67	1,56	1,46	36
39	1,7	1,88	1,5	1,43	1,31	39
42	1,55	1,71	1,36	1,29	1,2	42
45	1,42	1,57	1,24	1,18		45
48	1,3	1,44	1,13	1,08		48
51	1,2	1,32	1,04	1		51
54	1,11	1,23	0,96			54
57	1,03	1,14	0,9			57
58,5	1	1,1				58,5

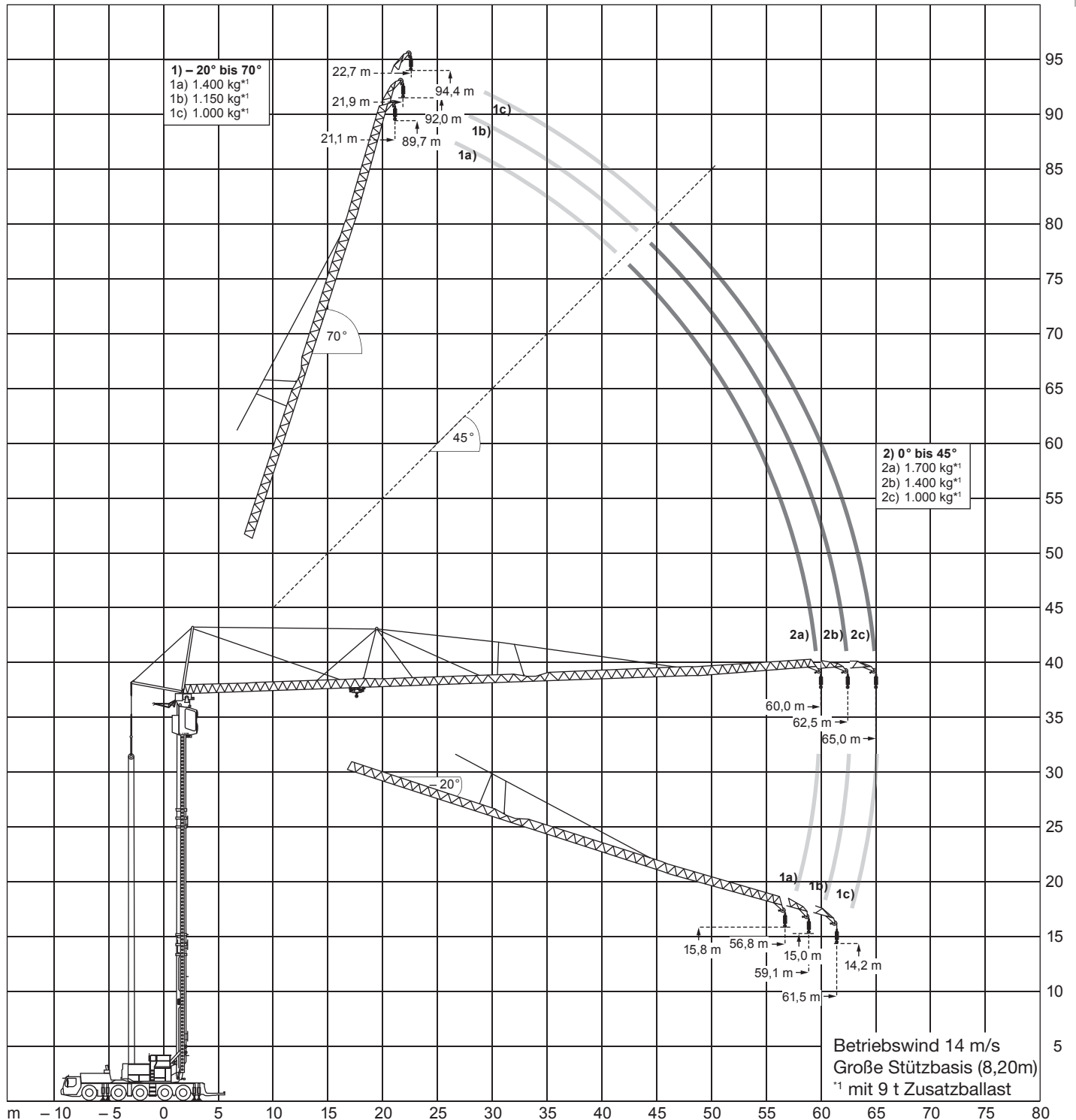

Verstellauslegerbetrieb

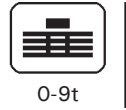

Alle Angaben ohne Gewähr und vorbehaltlich technischer Änderungen und Satzfehler.  
 All information given are for reference only

ZERTIFIZIERT  
 EN ISO 9001 · SCC\*



	60				62,5				65				
	9t	6t	3t	0t	9t	6t	3t	0t	9t	6t	3t	0t	
21,1-43	1,4	1,15	0,8	0,55									70° - 45°
43-60	1,7	1,4	1,15	0,8									45° - 0°
60-56,8	1,4	1,15	0,8	0,55									0° - -20°
21,9-44,7					1,15	0,8	0,65	0,3					70° - 45°
44,7-62,5					1,4	1,15	0,8	0,65					45° - 0°
62,5-29,1					1,15	0,8	0,65	0,3					0° - -20°
46,5-65									1	0,8	0,55	0,3	45° - 0°



Aufstellvorgang / Erection procedure

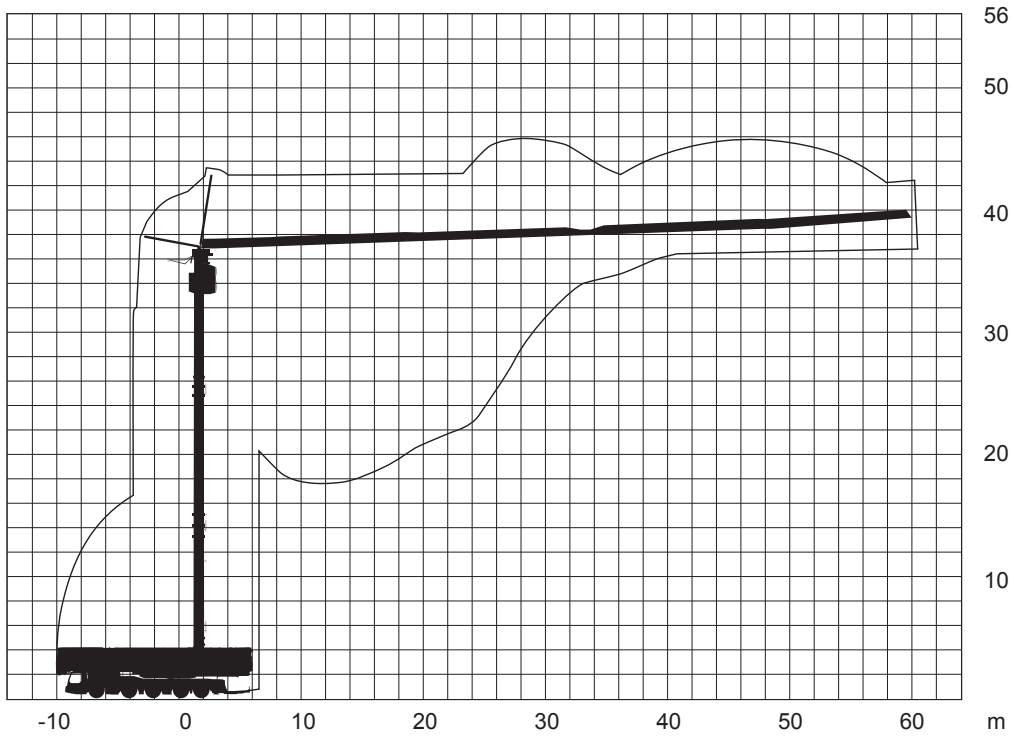
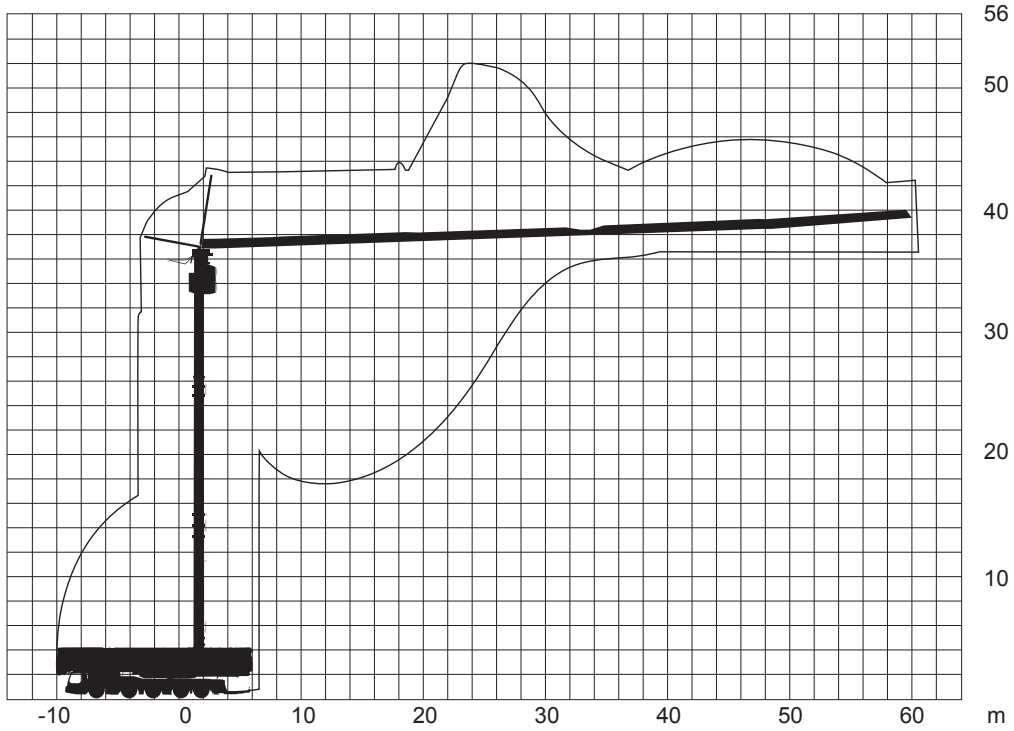

Alle Angaben ohne Gewähr und vorbehaltlich technischer Änderungen und Satzfehler.  
All information given are for reference only

ZERTIFIZIERT  
EN ISO 9001 · SCC\*

